

CONNECTION DIAGRAM

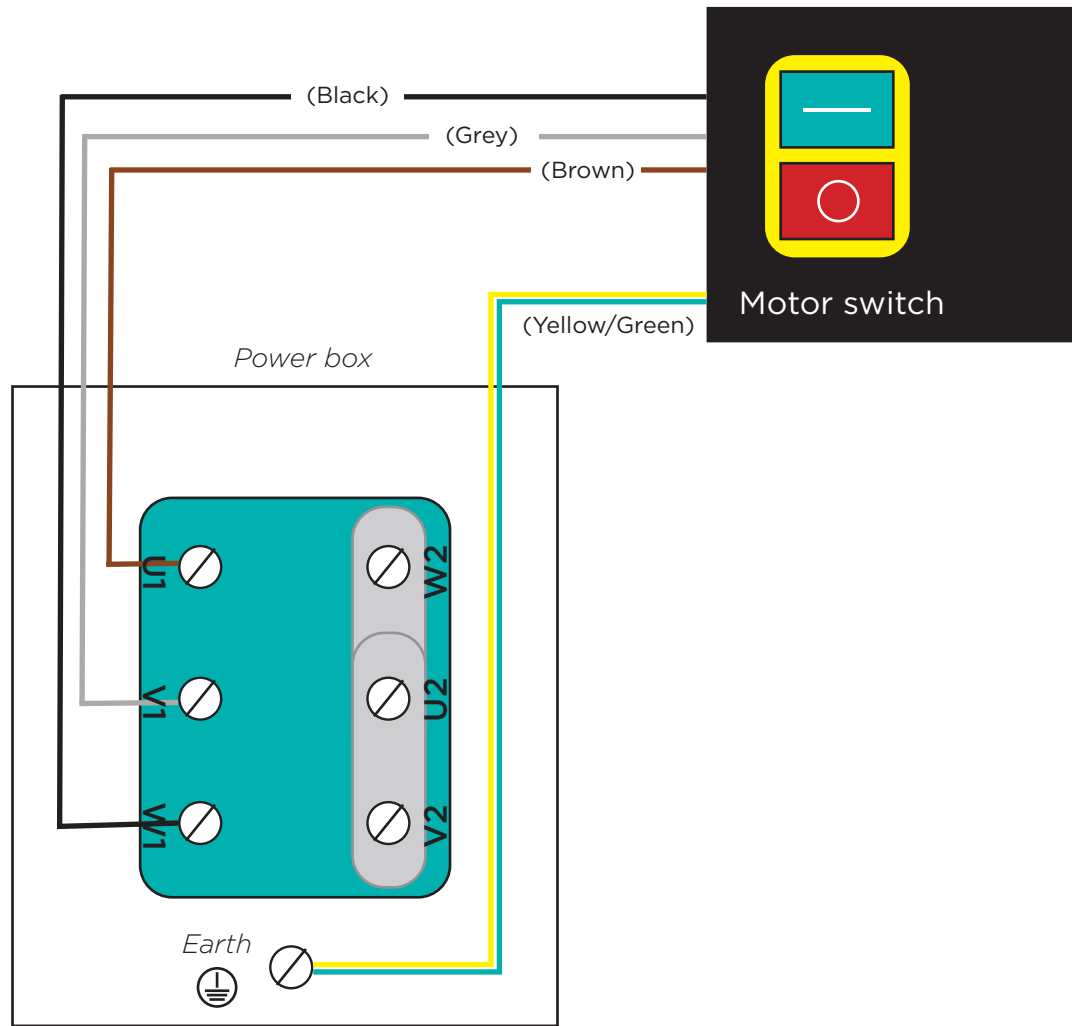

GB-14.08.20

- 400V, 2.2KW, 200L FORCED ACTION MIXERS -



See photos on the next page...

SALES SUPPORT / ADMIN
FABRIKSPARKEN 13 DK-2600 GLOSTRUP
+45 36 72 75 00 SALES@SOROTO.DK

PRODUCTION / WAREHOUSE
FABRIKSPARKEN 11 DK-2600 GLOSTRUP
+45 36 72 78 00 TEKNIK@SOROTO.DK

SOROTO@SOROTO.DK WWW.SOROTO.DK

